

SCREW TYPE EMI FILTERS [FTP Series]

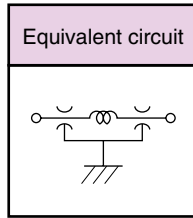
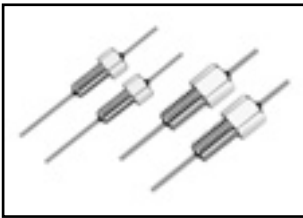

The FTP series filters are screw type EMI filters with π type circuit structure using a feed through ceramic capacitor and multilayer suppressors, and achieve large, steep attenuation to suppress EMI efficiently over a broad range up to GHz.

Metric thread type

Part Number List • Specifications for M3, M4 Thread Type

Part number	Capacitance	Capacitance tolerance	Rated voltage	Withstanding voltage	Rated current	Temperature characteristics	Temp. range	Insertion loss	Style
FTP302AS220S-S	22pF	+50% -20%	100Vdc	250Vdc	5Adc	S (+22~-22%)	-25~+85°C	①	Style 1
FTP302AS101S-S	100pF							②	
FTP302AS152S-S	1,500pF							③	
FTP302AS682S-S	6,800pF							④	
FTP302AS103S-S	10,000pF				⑤			10Adc	Style 2
FTP402AS222S-S	2,200pF				⑥				
FTP402AS103S-S	10,000pF				⑦				
FTP402AS223S-S	22,000pF				⑧				
FTP402AS473S-S	47,000pF				⑨				

Inch thread type

Part Number List • Specifications for No.5-44 UNF-2A, No.8-32 UNC-2A Thread Type

Part number	Capacitance	Capacitance tolerance	Rated voltage	Withstanding voltage	Rated current	Temperature characteristics	Temp. range	Insertion loss	Style
FTP322AS220S-S	22pF	+50% -20%	100Vdc	250Vdc	5Adc	S (+22~-22%)	-25~+85°C	①	Style 1
FTP322AS101S-S	100pF							②	
FTP322AS152S-S	1,500pF							③	
FTP322AS682S-S	6,800pF							④	
FTP322AS103S-S	10,000pF				⑤			10Adc	Style 2
FTP412AS222S-S	2,200pF				⑥				
FTP412AS103S-S	10,000pF				⑦				
FTP412AS223S-S	22,000pF				⑧				
FTP412AS473S-S	47,000pF				⑨				

Dimensions (mm)

Style 1

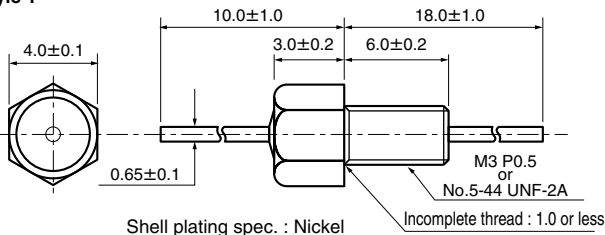

Style 2

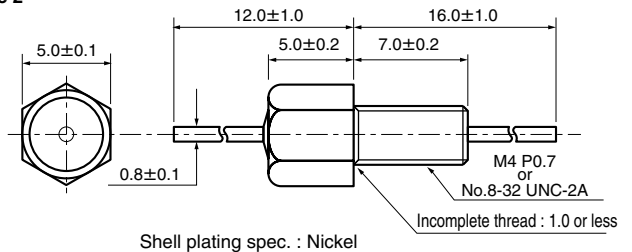

Insertion loss (Reference)

FTP30, FTP32 Type Insertion Loss data

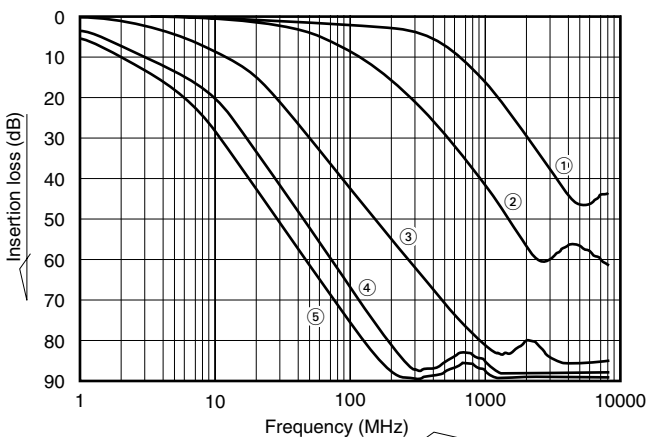

FTP40, FTP41 Type Insertion Loss data

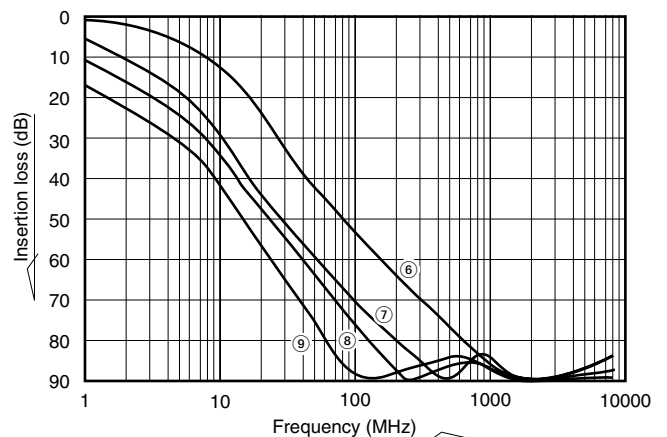

SCREW TYPE EMI FILTERS [FTP Series]

Part number	Capacitance	Capacitance tolerance	Rated voltage	Withstanding voltage	Rated current	Temperature characteristics	Temp. range	Insertion loss	Style
FTP822HF302PLTA-S	3,000pF	+100% -0%	500Vdc	1000Vdc	20Adc	F (+30~-80%)	-25~+85°C	①	Style 1

■ Dimensions (mm)

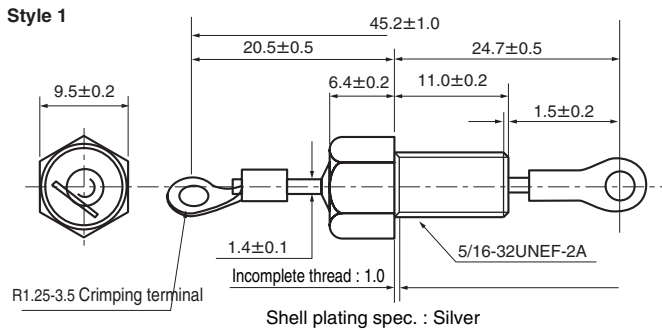

■ Insertion loss (Reference)

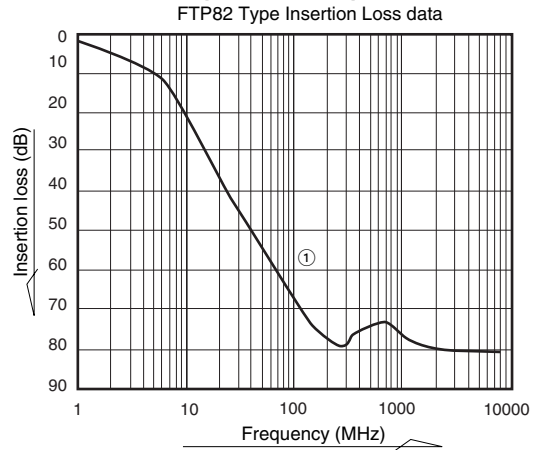

SCREW TYPE EMI FILTER ACCESSORIES

Nut and spring washer are prepared for as a option for the SCREW TYPE EMI filters. Please ask about installation by the nut. As for screw type nuts other than the list, please consult us.

■ Part Number List

Part name	Screw Type	W(mm)	T(mm)	Application
FT30N-S	M3×P0.5	4.0	1.5	FTA30,FTB30,FTT30,FTP30
FT40N-S	M4×P0.7	5.0	2.0	FTA40,FTP40,FTT40
FT4DN-S	M4×P0.5	5.0	2.0	FTA4D
FT50N-S	M5×P0.8	6.0	2.0	FTA5C
FT5BN-S	M5×P0.5	6.0	2.0	FTA5B,FTA5D

■ Dimensions

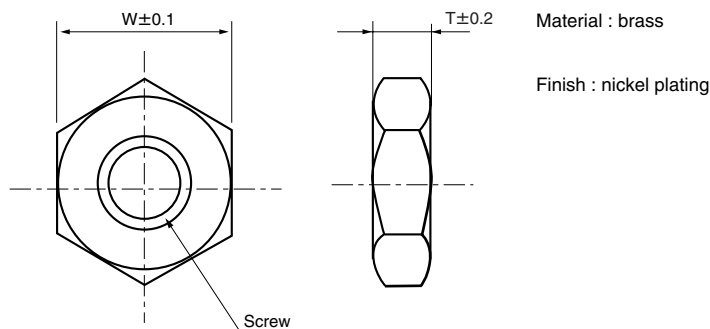

■ List of spring washers

Part name	D1(mm)	D2(mm)	T(mm)	Application
FT30SW	3.1	4.6	0.6	FTA30,FTB30,FTT30,FTP30
FT40SW	4.1	5.6	0.8	FTA40,FTA4D,FTP40,FTT40
FT50SW	5.1	6.8	1.0	FTA5C,FTA5B,FTA5D

■ Dimensions

